

**Olympian Plus Combinations  
Filter, Regulator and Lubricator  
G<sup>1</sup>/<sub>4</sub> to G<sup>3</sup>/<sub>4</sub>**

- **Olympian Plus plug in design**
- **High Efficiency water and particle removal**
- **Quick release bayonet bowls**
- **High visibility prismatic sight glass\***
- **Push to lock adjusting knob with tamper resistant option**
- **Constant oil density output with varying flow**

\* UK and other patents pending

**Technical Data**

Medium:

Compressed Air

Maximum pressure:

17 bar metal bowl

10 bar guarded transparent bowl

Operating Temperature:

-20°C\* to +80°C metal bowl

-20°C \*to +50°C guarded transparent bowl

\* Consult our technical service for use below +2°C

Gauge Ports:

R<sub>C</sub><sup>1</sup>/<sub>8</sub>

Maximum flow with 10 bar inlet pressure, 6,3 bar outlet pressure and pressure drop of 1 bar:

57 dm<sup>3</sup>/s

**Filter**

Filter Element:

40 µm nominal standard

5 µm nominal optional

**Regulator**

Recommended Regulating Pressure Ranges†:

0,3 – 10 bar standard

0,3 – 4 bar optional

2 – 16 bar optional

† Can be adjusted to zero bar outlet and, generally, to pressures in excess of those specified.

**Lubricator**

Start point at 6.3 bar:

1,5 dm<sup>3</sup>/s

Nominal Bowl capacity:

0,2 litres standard

Materials:

Aluminium bowl standard, guarded polycarbonate bowl optional. Zinc alloy body and yoke. Synthetic rubber elastomeric materials. Grilamid prismatic sight glass lens standard. Pyrex sight glass optional for metal bowl.

Filter: Sintered plastic filter element.

Regulator: Aluminium bonnet.

Lubricator: Polycarbonate sight dome.



**Ordering Information**

To order a standard Olympian Plus filter, regulator, lubricator combination quote model number from table overleaf.

For non-standard models substitute appropriate digits as instructed.



## Typical Performance Characteristics

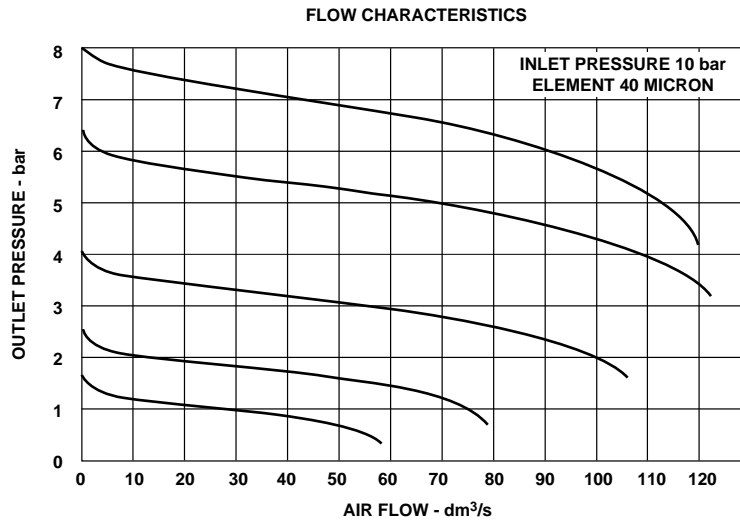

## Ordering Information

Standard models are supplied with automatic drains, 40µm elements, 10 bar range relieving regulators, Micro-Fog lubricators and metal bowls with prismatic sight glass.



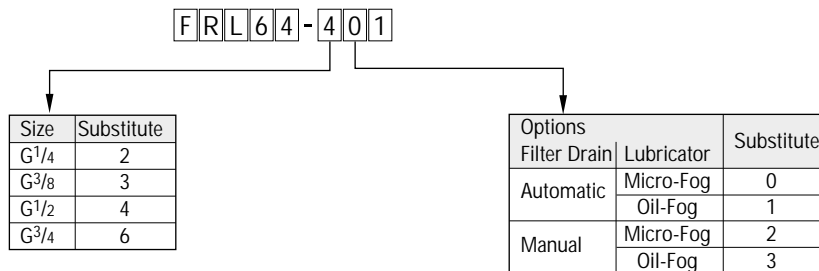

Port Size	Shut-Off Valve	Gauge	Bracket	Model	Weight kg
G <sup>1</sup> / <sub>2</sub>	✓	✓	✓	FRL64-401	4,61
	✓	✓		FRL64-402	4,42
	✓			FRL64-404	4,35
				FRL64-408	3,97

## Alternative Models

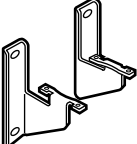

Please contact our technical service for details of non standard models including other thread forms, 'T' bar adjust, maximum pressure stop, 4 or 16 bar range adjustment and metal bowls with pyrex sight glass.

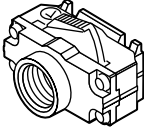
## Accessories

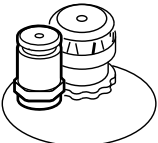
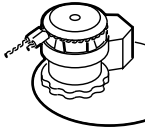
 Bracket Kit 74504-50	 Gauges 0- 6 bar: 18-013-012 0-10 bar: 18-013-013 0-25 bar: 18-013-014	 3/2 Shut-off Valve* G <sup>1</sup> / <sub>4</sub> T64T-2GB-P1N G <sup>3</sup> / <sub>8</sub> T64T-3GB-P1N G <sup>1</sup> / <sub>2</sub> T64T-4GB-P1N G <sup>3</sup> / <sub>4</sub> T64T-6GB-P1N	 Tamper Resistant Kit 4355-50
 Quick Fill Nipple 18-011-024	 Tamper Resistant Wire 2117-01 (Pack of 10)		

\* UK and other patents pending



**Dimensions (mm)**

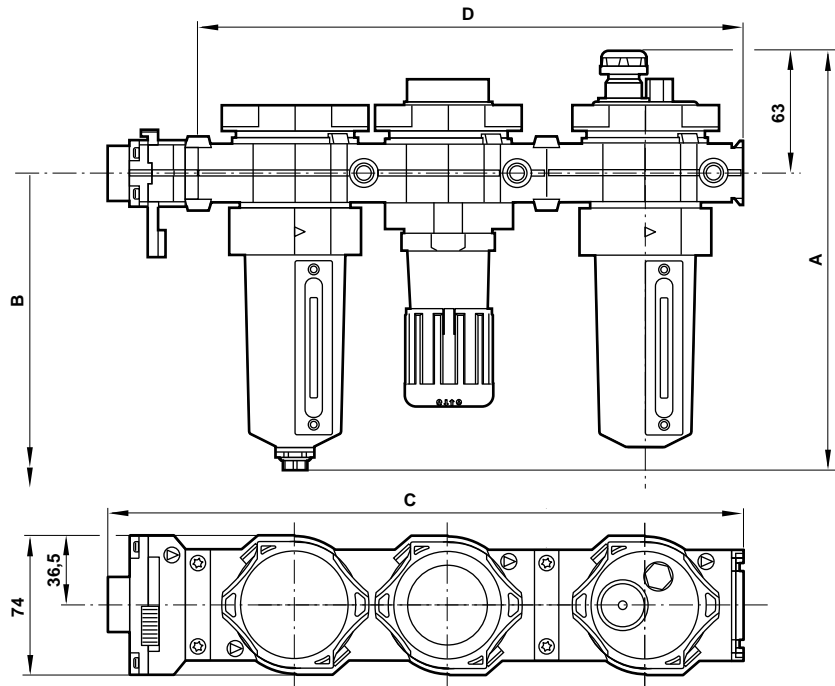

Dimension	Description	Drain	
		Automatic	Manual
A	Maximum overall height	227	234
B	Minimum clearance to remove unit	225	225
C	For port sizes G <sup>1</sup> / <sub>4</sub> , G <sup>3</sup> / <sub>8</sub> , G <sup>1</sup> / <sub>2</sub> , (G <sup>3</sup> / <sub>4</sub> )	338 (367)	338 (367)
D	Combination without shut-off valve, port sizes G <sup>1</sup> / <sub>4</sub> , G <sup>3</sup> / <sub>8</sub> , G <sup>1</sup> / <sub>2</sub> , (G <sup>3</sup> / <sub>4</sub> )	290 (342)	290 (342)

**Bracket Mounting**

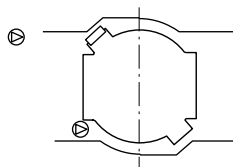
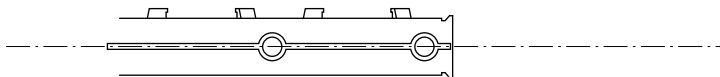

**Bracket Kit reference**

Model	Part No.
All Models	74504-50

**Service Kits**

Item	Type	Part number
Service kit	Filter	4380-200
Service kit	Relieving Regulator	4381-200
Service kit	Non-relieving Regulator	4381-201
Service kit	Lubricator	4382-200
Replacement elements	40 µm	4338-02
	5 µm	4338-01
Replacement sight glass	Prismatic (standard F64)	4380-040
	Prismatic (standard L64)	4380-042
	Pyrex	4380-041
Replacement drains	Automatic	3000-97
	Manual	684-84
Filter service indicator		5797-50

Filter service kit includes port seals, louver 'O' ring, bowl 'O' ring and drain gasket.  
 Regulator service kit includes port and bottom plug, 'O' rings, valve assembly, valve spring and diaphragm.  
 Lubricator service kit includes all seals, flow sensor, eyelet, dome screen, ball and spring.